

Please complete and display at your distribution board.

Warning

This building is fitted with Heat Mat 100% earth shielded electric underfloor heating utilising a 240Vac supply.

Do NOT pierce the floors above the system with nails, screws or other fasteners.
(see installer diagram for heater positioning)

Do NOT expose the floor to thermal blocking or attempt to reduce the size of the heated floor area.

(check suitability of floor covering with manufacturer & that furniture has 10mm (min) air void beneath it.)

In the event of flooding or when carrying out any repairs or alterations, disconnect the underfloor Heating and contact your electrician or Heat Mat for advice

Details of Installation:

Electricians Name:

Signature:

Company Name:
& Address:

Date:

Room with heating installed: _____

Total Wattage of system: _____

Please list the product code and test results of each element after installation (*compare to installation guide for rated resistance*)

| Product Code | Resistance Rating | Insulation Test Passed |
|--------------|-------------------|------------------------|
| | | |

Heat Mat Ltd - Tel No: 01444 247020

see www.heatmat.co.uk for more underfloor heating solutions

This installation guide should be left with the thermostat user manual and the installer's heater layout & wiring diagrams to meet IEE Wiring regulations (17th Edition – section 753). These items should be permanently fixed near the relevant distribution board.



High Quality, Ultra-Thin, 17th Edition Compliant Heating Mat

Fitting Guide – version 2

Call 01444 247020 for Technical Support

Underfloor Heating – made easy...



Heat Mat Limited, Ashwyn Business Centre,
Marchants Way, Burgess Hill. RH15 8QY

www.heatmat.co.uk

Reproduction of part or all of the contents of this fitting guide in any form is prohibited other than with the express written permission of Heat Mat Limited.

Please ensure you read this guide completely before commencing installation of the underfloor heating. If you are unsure of any aspect of the installation please call Heat Mat's Technical Support helpline on 01444 247020.

Contents

| | |
|---|-----------|
| Do's and Don'ts | 3 |
| Technical information | 4 |
| Basic wiring diagram and warning label | 5 |
| System and testing information | 6 |
| Installation instructions | 7 |
| Electrical information | 10 |
| Warranty information | 11 |

Before commencing your installation, please check that you have the correct heater or combination of heaters for your chosen area. (see page 6 for details)

Heat Mat Limited accept no liability, either express or implied, for any consequential losses incurred as a result of a Heat Mat system installation that does not conform to the following installation instructions.

Do's and Don'ts

- Do thoroughly read this guide before commencing installation
- Do ensure that all heating wire (including joints) is fitted beneath the floor covering
- Do use a multi-meter to test the mat, before, during and after covering (see page 4)
- Do connect multiple mats in parallel
- Do consider thermally insulating your sub-floor before installing the underfloor heating system
- Do use a Heat Mat thermostat to control your system
- Do ensure that all electrical works conform to Part 'P' of the Building Regulations and current IEE Wiring Regulations
- Do ensure the system is protected by a suitable RCD device (30mA)
- Do ensure that the cable is more than 30mm away from conductive parts such as water pipes
- Do remove cable from it's mesh to fit awkward areas
- Do ensure that all heating cable and connections are covered with tile adhesive or levelling compound
- Do log on to www.heatmat.co.uk to ensure that you are using the most recent instructions
- Don't cut, shorten, strain or cross the heating cables.
- Don't bend the joint between the element and cold tail
- Don't supply power to the heater until the mat has been fully encased and the wet trade has been allowed to fully dry out
- Don't lay cables closer than 3cm to each other or conductive parts
- Don't install the system if the ambient temperature is below 5°C as the cables on the mats can become less flexible
- Don't install the mats in walls or ceilings
- Don't install the floor sensor close to other heat sources such as hot water pipes
- Don't begin covering with tile adhesive or levelling compound until the mat is in place and has been tested with a multi-meter (see page 4)
- Don't leave any sections of the heating cable or connections in the open air or beneath fixtures and fittings when installation is completed
- Don't use the heating system to help to dry out the wet trade

Technical specification

200 W/m² Technical Specification

| Size in m ² | Length in Metres | Width in Metres | Wattage | Resistance |
|------------------------|------------------|-----------------|---------|------------|
| 1.0 m ² | 2.0 m | 0.5 m | 208 W | 277 Ω |
| 1.6 m ² | 3.2 m | 0.5 m | 310 W | 186 Ω |
| 2.0 m ² | 4.0 m | 0.5 m | 405 W | 142 Ω |
| 2.6 m ² | 5.2 m | 0.5 m | 512 W | 113 Ω |
| 2.8 m ² | 5.6 m | 0.5 m | 576 W | 100 Ω |
| 3.5 m ² | 7.0 m | 0.5 m | 719 W | 80 Ω |
| 4.2 m ² | 8.4 m | 0.5 m | 854 W | 67 Ω |
| 5.4 m ² | 10.8 m | 0.5 m | 1083 W | 53 Ω |
| 6.0 m ² | 12.0 m | 0.5 m | 1196 W | 48 Ω |
| 6.7 m ² | 13.4 m | 0.5 m | 1353 W | 43 Ω |
| 7.5 m ² | 15.0 m | 0.5 m | 1504 W | 38 Ω |
| 8.9 m ² | 17.8 m | 0.5 m | 1769 W | 33 Ω |
| 9.9 m ² | 19.7 m | 0.5 m | 1973 W | 29 Ω |

150/160 W/m² Technical Specification

| Size in m ² | Length in Metres | Width in Metres | Wattage at 230Vac | Resistance |
|------------------------|------------------|-----------------|-------------------|------------|
| 1.1 m ² | 2.2 m | 0.5 m | 168 W | 315 Ω |
| 1.5 m ² | 3.0 m | 0.5 m | 221 W | 240 Ω |
| 2.0 m ² | 4.0 m | 0.5 m | 318 W | 166 Ω |
| 2.3 m ² | 4.6 m | 0.5 m | 340 W | 155 Ω |
| 2.8 m ² | 5.6 m | 0.5 m | 401 W | 132 Ω |
| 3.1 m ² | 6.2 m | 0.5 m | 454 W | 116 Ω |
| 3.7 m ² | 7.4 m | 0.5 m | 546 W | 97 Ω |
| 4.4 m ² | 8.8 m | 0.5 m | 644 W | 82 Ω |
| 5.2 m ² | 10.4 m | 0.5 m | 781 W | 68 Ω |
| 6.2 m ² | 12.4 m | 0.5 m | 919 W | 58 Ω |
| 6.8 m ² | 13.6 m | 0.5 m | 1013 W | 52 Ω |
| 7.7 m ² | 15.4 m | 0.5 m | 1154 W | 43 Ω |
| 8.7 m ² | 17.4 m | 0.5 m | 1300 W | 40 Ω |
| 10.4 m ² | 20.8 m | 0.5 m | 1543 W | 34 Ω |

Technical Data:

| | |
|------------------------------|---|
| General Construction: | Dual conductor wire with earth |
| Voltage: | 240 Vac – 50Hz |
| Maximum Load: | 15 W/m |
| Maximum Cable Temperature: | 90 °C |
| Approvals: | CE Marked, VDE and BEAB system approved |
| Wire Thickness: | 2.7mm to 3.2mm depending on Ohm Value |
| Cable Flexibility: | Minimum allowable cable radius is 18mm |
| Power Range: | 168W to 1973W |
| Approved in accordance with: | EN 60335-1:1998, EN60335-2-17:1999, IEC 60730 |

Construction:

| | |
|--------------------------|--|
| Thermal Conductor: | 2 x resistance wire insulated with Teflon (FEP 7Y) tested to 200°C |
| Outer Insulation: | PVC (Y) tested to 90°C |
| Reinforcement Materials: | Fibreglass strands |
| IP Rating: | IPX7 |
| Reinforcement Mesh: | Fibreglass mesh |
| Fixing Materials: | Supplied with rows of double-sided tape |



150 W/m² Mat Outputs are calculated at 230Vac

Basic wiring diagram and warning label

Typical Wiring System

- All electrical works must be carried out by a certified electrician.
- A suitable RCD protection must be incorporated in this system.
- If the ampage of the thermostat is exceeded by your chosen system, a contactor or similar device will be required. All thermostats used must be of a two-pole design with a minimum opening between the contacts of 3mm. For full BEAB system approval you must use a suitable Heat Mat BEAB approved thermostat.
- The heating cables must not be cut or cross each other or other wiring.
- The cold tail joint must be kept straight and located beneath the final floor covering and must be thoroughly encased in tile adhesive or levelling compound.
- Please consult your electrician to discuss your individual requirements.

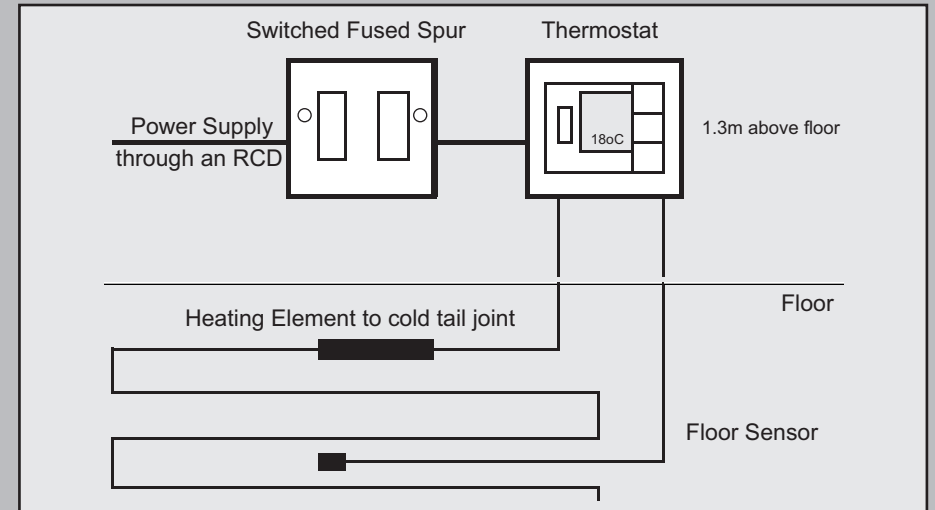

Please see the back page of this fitting guide for the required information label for the distribution board.

It is a legal requirement that this label is completed and the required information is displayed near the relevant distribution board.

Guide to choosing the correct system

As a guide to confirming the wattage per square metre (W/m²) that you require, please use the following advice in conjunction with the tables on page 4.

150W/m² Table – Standard rooms:

When using any suitable floor covering including tiles, carpet, vinyl or wood. These mats can be laid straight onto wooden or *insulated concrete bases. They can provide primary heating in well insulated areas and secondary heating in other circumstances. (Please note a levelling compound will be required for use with any floor covering other than tiles.)

200W/m² Table – High heat loss rooms:

When using beneath tiles on insulated concrete bases and when primary heating is a priority. The 200W/m² system is capable of providing primary heating in almost any situation providing the sub-floor is reasonably *insulated. Speak to your electrician or builder to confirm that the system output meets your individual requirements.

* Insulation within the floor base minimises downward heat loss allowing your underfloor heating to run more efficiently. Insulation laid directly beneath the underfloor heating will provide the largest benefit, and the further down in the floor build the insulation is (such as beneath a screed) the less benefit it will offer. Systems laid onto very badly insulated floor bases may not meet your expectations.

Testing your Heating Mat with a multimeter

Test your heating mat with a multimeter before unwrapping to confirm you have received it in working order.

The black coldtail is double insulated and carries an earth screen (silver braid), live and neutral wires.

Exposing the ends of these wires will allow the continuity tests to be carried out with a functional multimeter.

This test should also be done before, during and after tiling.

Calculating coverage:

Although 100% coverage is achievable, a border of 2-4cm is recommended around the perimeter of the room as the heating cables should not touch the walls, kickboards etc. In normal circumstances we would recommend deducting between 5 and 10% from the total free floor space that you wish to heat, to give you the square metres of heating mat that you should install. For areas above 8m² we would recommend only deducting 5%.

For instance: You have a 15.0m² kitchen that is going to have a tiled floor and contains units that will take up 2.8m² of the floor area, which therefore should not be heated. You wish to use a 200W/sqm heating mat system. The calculation you should use is as follows: 15.0m² – 2.8m² = 12.2m² then 12.2m² – 5% = 11.59m²

Referring to the table on page 4, the best combination of heating mats would be:

1 x 9.9m² 200W mat and 1 x 1.6m² 200W mat.

We would recommend planning your installation before starting to lay your system, and also that you photograph your system layout before tiling for future reference.

At no point should any cable be connected to a power supply to test it.

Tests

- Live to neutral = ohms value as in table on page 4
- Live to earth and neutral to earth = both infinity.

If your tests do not conform to the expected results please contact Heat Mat's Technical Support Team.

Installation instructions

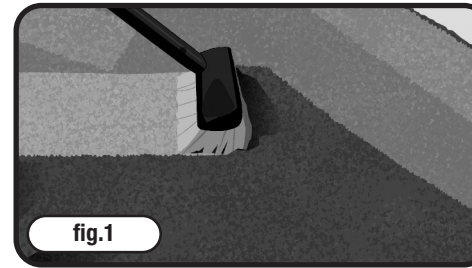

fig.1

Floor preparation

Ensure the sub-floor is solid, level and dust free. Wooden floors can be reinforced using 18mm WPB plyboard, 10mm Marmox Insulation boards or suitable Tilebacker boards. We would also recommend that the entire floor base is of the same construction to ensure the system performs evenly. If the floor construction is not uniform you should use Marmox boards or similar to provide a uniform base.

The sub-floor should be insulated to current building regulations, however, if you are unsure how well insulated your sub-floor is, Heat Mat can supply 6, 10 or 20mm Marmox Insulation boards. Insulation improves the performance and efficiency of your system, therefore reducing running costs. If there is little or no insulation within the sub-floor we would recommend using a suitable layer of insulation.

If installing Marmox boards, these should be secured with flexible tile adhesive onto concrete sub-floors, or with galvanised screws and washers onto timber bases. Reinforcement tape should be used across the joins. See www.heatmat.co.uk for further details.

If you do not have the build height required for Marmox boards Heat Mat supply i-primer thermal primer which, although less effective than Marmox boards, can reduce downward heat loss by up to 20%. The thermal primer is acrylic based and should be compatible with all flexible tile adhesives. If in doubt please confirm compatibility with the tile adhesive manufacturer.

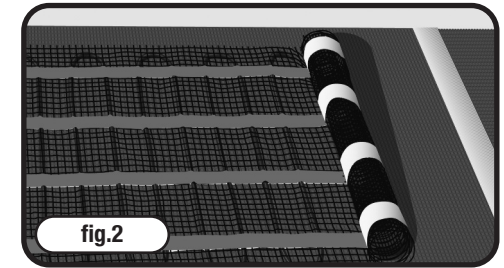

fig.2

Installing the Ultra-Thin Heating Mat System

Test each mat with a multi meter before unpacking to ensure you have received your product in full working order. See the bottom of page 6 for testing instructions.

Draw a plan of how you intend to fit your mat/s.

Roll out your first mat onto your floor mesh side up. (fig.2) Cut across the fibre glass mesh when you reach an obstruction, carefully avoiding the heating cable, and you can then flip the mat around and start laying it in the opposite direction (figs.3 and 4). In awkward areas the heating cable can be removed from the fibre glass mesh and laid loosely to ensure the heating system fits your room. When doing this, try to keep the spacing between the cables similar to that on your mat to maintain an even output across the floor area and never let the cables touch or cross. The cables should be secured to the floor with double sided tape.

Once in position, remove the backing from the adhesive tape attached to the underside of your mat/s and secure to your base (fig 5). Any loose cable or mesh can be secured by using a hot glue gun or masking tape.

The cables should never be less than 30mm apart whether they are on the heating mat or laid loosely. If you find that you have to lay the cable separated from the mat in rows less than 30mm apart to fit your room, STOP, as the matting is too big for your area. The heating cable can not be cut to shorten itself without destroying it.

If using our thermal primer to insulate your floor you should ensure the room is well ventilated during

Installation instructions

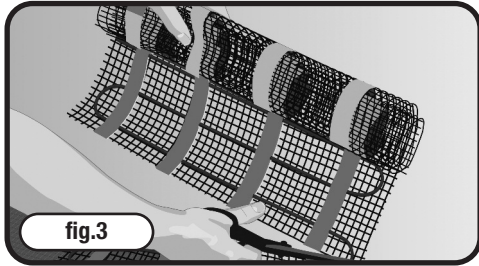

application and drying. The thermal primer can reduce heat loss through the base by up to 20%. (fig.1)

Ensure that both sections of each mat with orange warning labels are kept straight and laid flat to the floor beneath your final floor covering. These will have to be chased into the sub-floor to ensure they rest at the same height as the top of the heating cable. These must not be covered with tape, but do have to be fully encased in tile adhesive. (fig.6)

Position the floor sensor (contained inside the thermostat box), halfway between two runs of the heating elements (fig.7). The floor sensor should not cross the heating cable and should be placed approx. 40cm into the heated floor space. The floor sensor at the end of the cable should also be chased into the sub-floor so it lies level with the top of the heating cables. The sensor cable can be extended if required up to 50m using a twin sheathed high temperature PVC cable and the connection between the two wires must be waterproof and fully insulated. Ideally, the floor sensor should be placed into a length of suitable close ended conduit (12-14mm diameter) so that it can be easily replaced if required.

The floor sensor should not be fitted in areas affected by other heat sources, such as hot water pipes and radiators, or in an area that will be covered at a later date with items such as rugs or flat bottomed furniture, as this will prevent the system from operating correctly.

If using one of Heat Mat's infra-red wall mounted floor sensors you are not required to include an additional floor sensor within the floor construction.

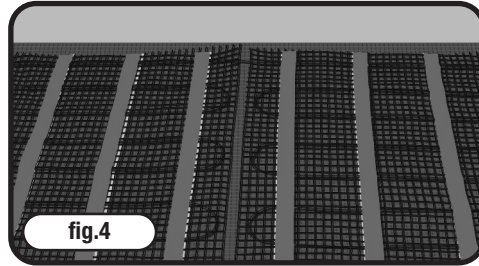

Multiple mats can be installed in one room but must be connected in parallel (they do not join together). Up to 2 heating mats can be wired directly into the back of the thermostat. More than two mats will require a connection box. If your chosen system exceeds 16amp (approximately 3,600 watts), additional thermostats can be used or your electrician can install a contactor or similar device to allow the heating system to operate safely through a single thermostat.

Test the heating system with a multi meter again prior to covering. We would recommend taking a photograph of the layout of your system and the positioning of the floor sensor at this stage for future reference.

If covering is not going to happen straight away, protect the heater/s by covering with cardboard or carpet and restrict any traffic above the cable to a minimum. After removing the protective covering before laying the final floor covering you should check the continuity of the cable before proceeding.

Covering the Heating Mat System

Wear soft soled shoes and cover the system with carpet/cardboard to protect it where you are working during installation. Do not allow any unnecessary traffic across the cabled area until the floor covering is completed. Do not stack or cut tiles across the cabled area and take care to avoid dropping sharp objects or tiles onto the cables as this can crush or cut into them.

Installation instructions

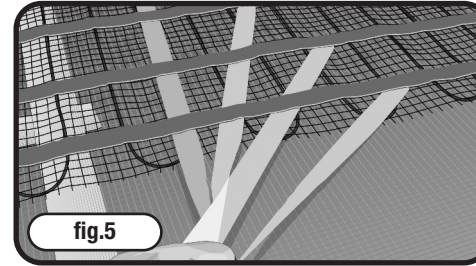

Check the resistance and continuity of the cable with a multimeter regularly during installation. If the resistance changes, or the cable goes to open circuit, the cable has been damaged. In this case, please contact Heat Mat's Technical Support line on 01444 247020. Even a small nick in or scratch to the outer insulation can lead to system failure when powered up over a period of time.

Heat Mat can supply Mira Thermoplan levelling compound to encapsulate the heating cable (mosaic tiles, carpets, vinyl and wood coverings require a layer 10-12mm from base level). Using a suitable flexible levelling compound reduces the risk of damage to the cables caused by using tile trowels and should a tile need to be replaced in the future, the heating cable is less likely to be damaged. Air pockets around the cables are also less likely with this method of installation. See www.heatmat.co.uk for further details on Mira installation.

Whether using flexible levelling compound or tile adhesive to cover your cable, you should avoid leaving air pockets around the heating cable. In no circumstances must tiles be laid with dabs of adhesive, they must always be fully bedded in.

If using tile adhesive and grout to complete your installation they must be suitable for underfloor heating, the main requirement being that they are 'flexible' adhesives and grouts. Please refer to the manufacturers instructions to confirm suitability.

If using flexible tile adhesive, a plastic notched trowel should be used to push the adhesive along the cable rather than against it. Care should be exercised to prevent damage

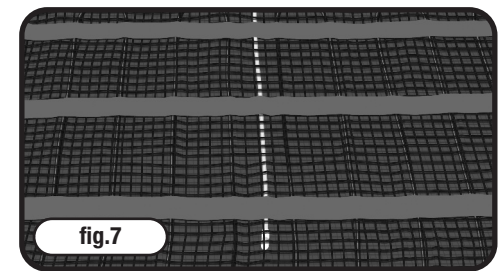

to or dislodging of the heating cables. Ideally, lay carpet or cardboard on top of the exposed cable and use this as a crawl board to avoid damaging the system.

Although the cable is reinforced, it is ideal if the trowel does not make contact with the cable itself.

If a tile needs to be moved after placement this must be done carefully to avoid damaging the heating cable.

The floor should be grouted with a flexible grout, and particular care should be taken not to damage the heating system when cleaning out any grout lines. The underfloor heating must never be used to 'dry out' the tile adhesive. The system must not be turned on until the adhesive, grout and/or levelling compound is completely dry. This would normally take at least seven days, but please refer to the appropriate manufacturers instructions for confirmation.

Once the floor covering is laid, test the resistance and continuity of the heating mats individually to confirm they are undamaged.

Installation instructions

Electrical connections

Wiring can now be completed but no power should be applied to the system until the adhesive, grout and/or levelling compound is completely dry.

All work must comply with current IEE wiring regulations and installations must comply with Part 'P' of the Building Regulations. Consult your Local Authority Building Control department regarding their requirements for certification or check with an electrician qualified to issue Part 'P' certification regarding your individual installation.

The heating mat/s have to be wired into a thermostat with floor temperature limitation. Please see the separate instructions in your Heat Mat thermostat box.

Run the coldtail connection and floor sensor cable in separate plastic conduit or trunking from your heated floor to the thermostat position.

Up to 2 heating mats can be wired straight into the thermostat. A connection box will be required if installing 3 or more heating mats. Ensure that multiple mats are wired in parallel, not in series.

The mains power supply must be protected by a suitable RCD (30mA and up to 4.8kW).

The thermostat should be connected to the power supply via a suitably rated fused spur or circuit breaker.

Heat Mat's thermostats are rated 16 Amp and if the total loading from a combination of heating mats exceeds this, the system will require multiple thermostats or we would recommend the installation of a suitable rated contactor which would allow the heating system to be run through a single thermostat for ease of control.

Heat Mat's thermostats are IP21 rated, which means that they can be installed within a wet area in Zone 3 if it is available.

If the thermostat is placed outside the room to be heated, or inside a cupboard, the thermostat will have to be reprogrammed (when first switched on) to only monitor the floor sensor that has been placed into the heated floor space.

Remember:

If you are unsure how to proceed at any stage of the installation process, please contact Heat Mat Technical Support on 01444 247020 for guidance.

Living with your Underfloor Heating System

To ensure that your system works to its full capacity for the lifetime of the flooring, please ensure that thermal blocking is avoided above the heating system.

Thermal blocking occurs when the heat produced by the system warms the floor surface but is then trapped and has no way of escaping from the surface of the floor. This can cause the system to overheat in the thermally blocked area and, in extreme cases, affect the integrity of the floor covering and heating system.

Heat Mat's thermostats are IP21 rated, and the heating mats are IPX7 rated, which means systems can be installed in bathrooms and other 'wet areas' and if a suitable zone is available the thermostat can also be placed in the bathroom.

Thermal blocking is not usually a problem within floors where the system has been covered with levelling compound or tile adhesive and tiles, as these coverings are efficient transmitters of heat themselves and will spread the heat around any thermal block. Thermal blocking has a greater chance of occurring in situations with a carpeted, wooden or laminate floor finish that do not utilise a levelling compound as these coverings do not transmit heat as effectively.

Heat Mat Lifetime Warranty



Congratulations on your purchase of a Heat Mat electric underfloor heating system.

The ultra-thin heating mat has been manufactured and supplied in the European Union by Heat-Com a/s/Heat Mat Limited, and the following Warranty is supplied in accordance with the general product liability rules, as stated in Directive 85/374/CEE, and all relevant national laws. You are provided with a fifteen year warranty on the ultra-thin heating mat for eventual defects in material. Details and evidence of defects has to be presented to Heat-Com, Heat Mat or an authorised UK or Ireland distributor for approval.

When your warranty is invoked, your damaged product will either be repaired or replaced free of charge to yourself.

Your warranty does not cover the following:

- Any faults caused by misuse.
- A system which has not been installed in accordance with the manufacturer's guidelines.
- Any other subsequential or consequential damages.
- Any system that had not been paid for in full.

Heat-Com a/s/Heat Mat Limited are covered by an international insurance covering warranty payments.

In addition to the above warranty, Heat Mat offer a lifetime extension to the above warranty on your ultra-thin heating mat. To be covered by this extra warranty in addition to the above stipulations you must also:

- Register your product at www.heatmat.co.uk/warrantyregistration within 90 days of purchase.
- Be able to provide your proof of purchase of the system, a normal retail invoice/receipt is sufficient for this purpose.
- Ensure the system has been installed in accordance with Heat Mat's installation guidelines and it must be protected by a suitable RCD.
- Ensure that all installation work is compliant with current IEE wiring regulations and installations must comply with Part 'P' of the Building Regulations. You should retain your Part 'P' certificate as proof of this.

If the above stipulations have been followed, Heat Mat will provide a lifetime warranty once the original fifteen year warranty expires for the ultra-thin heating mat. This warranty runs for the life of the floor covering above the original installation. This warranty covers manufacturing defects in the ultra-thin heating mat supplied. Details and evidence of defects has to be presented to Heat Mat or an authorised UK or Ireland distributor for approval. When your warranty is invoked, your damaged product will either be repaired or replaced free of charge to yourself.

The repair or replacement of your system is the only remedy available to you under these warranties. None of the above warranties affect your statutory rights. Heat-Com a/s and Heat Mat Limited will in no event be liable for consequential losses or secondary charges including but not restricted to the cost of replacing or repairing floor coverings, any costs associated with utility expenses or running costs, professional fees relating to trades peoples' subsequent work or any other damage caused to material items.

**Heat Mat Limited,
Ashwyn Business Centre,
Marchants Way,
Burgess Hill. RH15 8QY**

**T 01444 247020
F 01444 247121
www.heatmat.co.uk**